

INSTALLATION MAP

↑ To Sheet / A la hoja de: _____

Panel Group/Grupo de los paneles: Azimuth/Azimet: Tilt/Inclinación: Sheet/Hoja _____ of/de _____	Customer/Cliente:			Installer/Instalador:			N S E W N S E O 		
	1	2	3	4	5	6	7	8	9
A									
B									
C									
D									
E									
F									
G									
H									
J									
K									
L									
M									

To Sheet / A la hoja de: ↑

To Sheet / A la hoja de: ↓

Scan completed map and upload it to Enphase. Click “Add a New System” at <https://enlighten.enphaseenergy.com>. Use this map to build the virtual array in Enlighten’s Array Builder.

Escanee el mapa completo y cárguelo en Enphase. Haga clic en “Añadir nuevo sistema” en <https://enlighten.enphaseenergy.com>. Utilice este mapa para crear el conjunto de paneles virtual en el Creador de conjuntos de paneles de Enlighten.

Envoy Serial Number Label /
Número de serie de Envoy



Enphase Customer Support: enphase.com/en-us/support/contact

↓ To Sheet / A la hoja de: _____

QUICK INSTALL GUIDE



Install the Enphase IQ 7A Microinverter

To install Enphase IQ Series Microinverters, read and follow all warnings and instructions in this guide and in the *Enphase IQ 7 and IQ 7+ and IQ 7X Microinverter Installation and Operation Manual* at: enphase.com/support. Safety warnings are listed on the back page of this guide.

The Enphase Microinverter models listed in this guide do not require grounding electrode conductors (GEC), equipment grounding conductors (EGC), or grounded conductor (neutral). The microinverter has a Class II double-insulated rating, which includes ground fault protection (GFP). To support GFP, use only PV modules equipped with DC cables labeled **PV Wire** or **PV Cable**.

IMPORTANT: Enphase IQ Series Microinverters require the Q Cable and are not compatible with previous Enphase cabling. An IQ Envoy is required to monitor performance of the IQ Microinverters. The Q Accessories work only with Enphase IQ Series Microinverters.

PREPARATION

A) Download the Enphase Installer Toolkit mobile app and open it to log in to your Enlighten account. With this app, you can scan microinverter serial numbers and connect to the Enphase IQ Envoy to track system installation progress. To download, go to enphase.com/toolkit or scan the QR code at right.



B) Refer to the following table and check PV module electrical compatibility at: enphase.com/en-us/support/module-compatibility

Model	DC connector	PV module cell count
IQ7A-72-2-US	MC4 type, locking	Pair with 60- or 72-cell modules

C) In addition to the Enphase Microinverters, PV modules and racking, you will need these **Enphase items**:

- Enphase IQ Envoy (model ENV-IQ-AM1-240) communications gateway or IQ Combiner (model X-IQ-AM1-240-B, X-IQ-AM1-240-2, X-IQ-AM1-240-3, X-IQ-AM1-240-3C): is required to monitor solar production.
- Tie wraps or cable clips (Q-CLIP-100)
- Enphase Sealing Caps (Q-SEAL-10): for any unused connectors on the Enphase Q Cable
- Enphase Terminator (Q-TERM-10): one needed at the end of each AC cable segment
- Enphase Disconnect Tool (Q-DISC-10)
- Enphase Q Cable:

Cable model	Connector spacing*	PV module orientation	Connectors per box
Q-12-10-240	1.3m	Portrait (all)	240
Q-12-17-240	2.0m	Landscape (60-cell)	240
Q-12-20-200	2.3m	Landscape (72-cell)	200

*Allows for 30cm of cable slack

D) Check that you have these other items:

- Enphase Q Aggregator or AC junction box.
- Tools: screwdrivers, wire cutter, voltmeter, torque wrench, sockets, and wrenches for mounting hardware

E) Protect your system with lightning and/or surge suppression devices. It is also important to have insurance that protects against lightning and electrical surges.

F) Plan your AC branch circuits to meet the following limits for maximum number of microinverters per branch when protected with a 20-amp over-current protection device (OCPD).

Maximum* IQ Micros per AC branch circuit	IQ 7A Micros (240V single phase)
	11
	IQ 7A Micros (208V single phase)
	11

*Limits may vary. Refer to local requirements to define the number of microinverters per branch in your area.

G) Size the AC wire gauge to account for voltage rise. Select the correct wire size based on the distance from the beginning of the Enphase Q Cable to the breaker in the load center. Design for a voltage rise total of less than 2% for these sections. Refer to the Voltage Rise Technical Brief at enphase.com/support for more information.

Best practice: Center-feed the branch circuit to minimize voltage rise in a fully-populated branch. Using the Q Aggregator is a convenient way to do this.

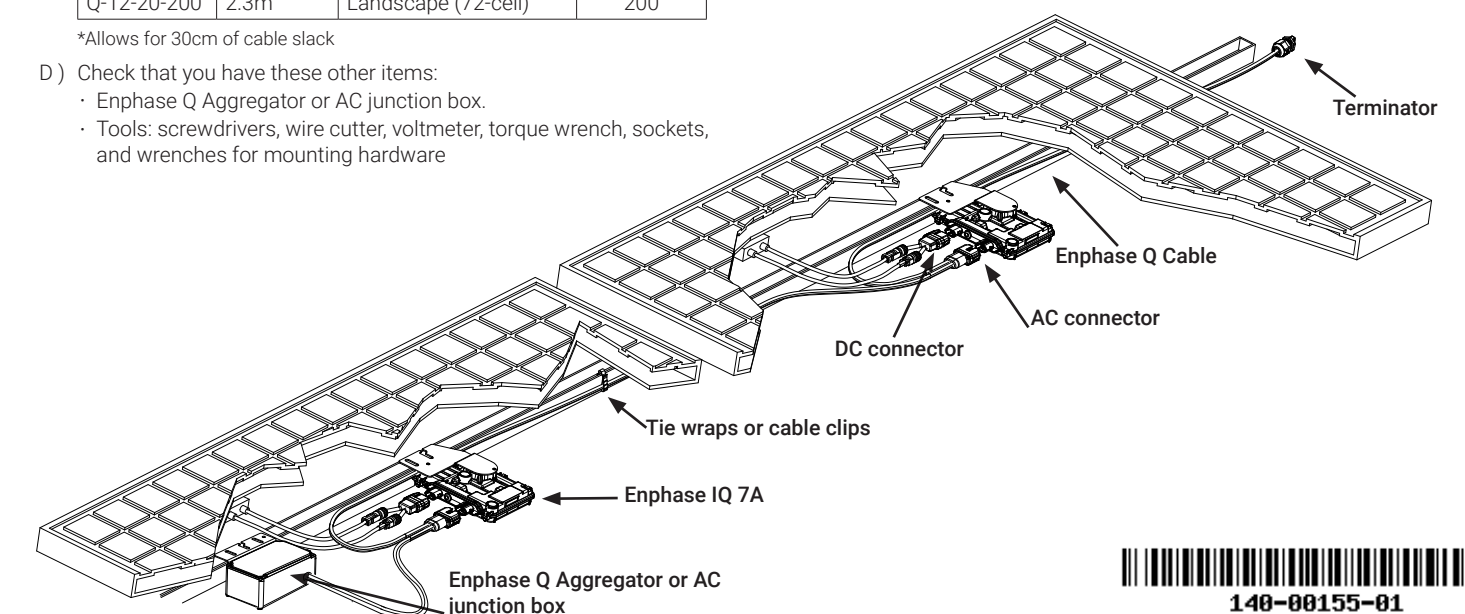

INSTALLATION

1 Position the Enphase Q Cable

- Plan each cable segment to allow connectors on the Enphase Q Cable to align with each PV module. Allow extra length for slack, cable turns, and any obstructions.
- Mark the approximate centers of each PV module on the PV racking.
- Lay out the cabling along the installed racking for the AC branch circuit.
- Cut each segment of cable to meet your planned needs.



WARNING: When transitioning between rows, secure the cable to the rail to prevent cable or connector damage. Do not count on the connector to withstand tension.

2 Position the Enphase Q Aggregator or Junction Box

- Verify that AC voltage at the site is within range:

Service Type and Voltage: L1 - L2	
240 V single phase	211 to 264 VAC
208 V single phase	183 to 229 VAC

- Install an Enphase Q Aggregator or junction box at a suitable location on the racking. See the *Enphase Q Aggregator Quick Install Guide*.
- Provide an AC connection from the Enphase Q Aggregator or junction box back to the electricity network connection using equipment and practices as required by local jurisdictions.

3 Mount the Microinverters

- Mount the microinverter bracket side up (as shown) and under the PV module, away from rain and sun. Allow a minimum of 1.9 cm (0.75 inches) between the roof and the microinverter. Also allow 1.3 cm (0.50 inches) between the back of the PV module and the top of the microinverter.



WARNING: Install the microinverter under the PV module to avoid direct exposure to rain, UV, and other harmful weather events. Do not mount the microinverter upside down.

- Torque the mounting fasteners (1/4-inch or 5/16-inch) as follows. Do not over torque.
 - 6 mm (1/4 inches) mounting hardware: 5 N m (45 to 50 in-lbs)
 - 8 mm (5/16 inches) mounting hardware: 9 N m (80 to 85 in-lbs)
 - When using UL 2703 mounting hardware, use the manufacturer's recommended torque value

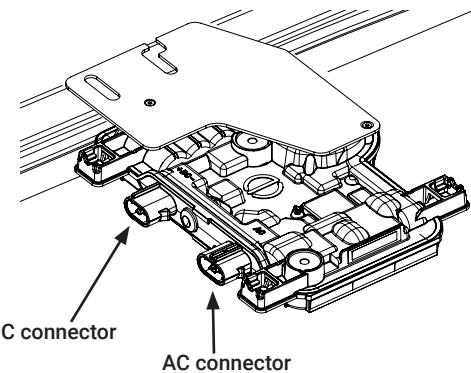

4 Create an Installation Map

Create a paper installation map to record microinverter serial numbers and position in the array.

- Peel the removable serial number label from each microinverter and affix it to the respective location on the paper installation map.
- Peel the label from the IQ Envoy and affix it to the installation map.
- Always keep a copy of the installation map for your records.

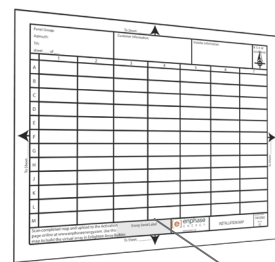

Affix serial number labels

5 Manage the Cabling

- Use cable clips or tie wraps to attach the cable to the racking. The cable must be supported at least every 1.8 m (6 feet).
- Dress any excess cabling in loops so that it does not contact the roof. Do not form loops smaller than 12 cm (4.75 inches) in diameter.

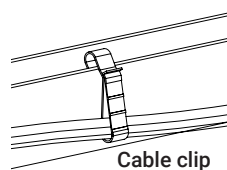

6 Connect the Microinverters

- Connect the microinverter. Listen for a click as the connectors engage.
- Cover any unused connectors on the AC cable with Enphase Sealing Caps. Listen for a click as the sealing caps engage.

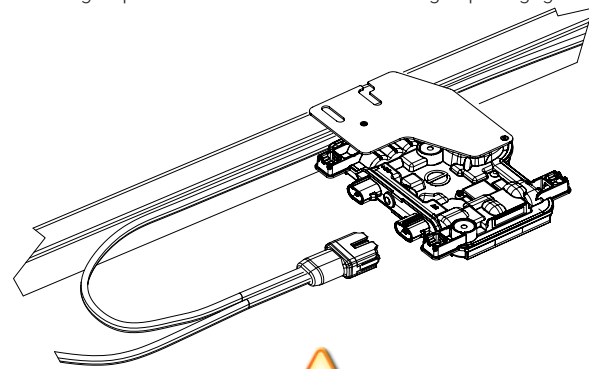

WARNING: Install sealing caps on all unused AC connectors as these connectors become live when the system is energized. Sealing caps are required for protection against moisture ingress.

To remove a sealing cap or AC connector, you must use an Enphase disconnect tool.

7 Terminate the Unused End of the Cable

- Remove 13 mm (1/2") of the cable sheath from the conductors. Use the terminator loop to measure.

Terminator Body

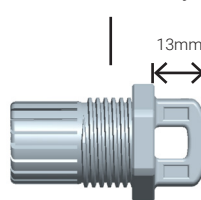

- Slide the hex nut onto the cable. There is a grommet inside of the terminator body that should remain in place.
- Insert the cable into the terminator body so that each of the two wires land on opposite sides of the internal separator.

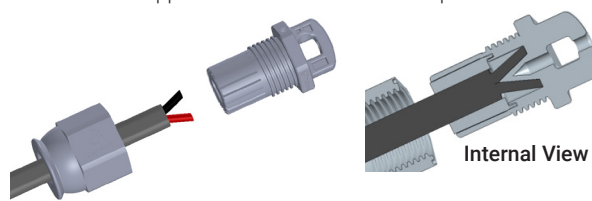

- Insert a screwdriver into the slot on the top of the terminator to hold it in place, and torque the nut to 7 Nm.

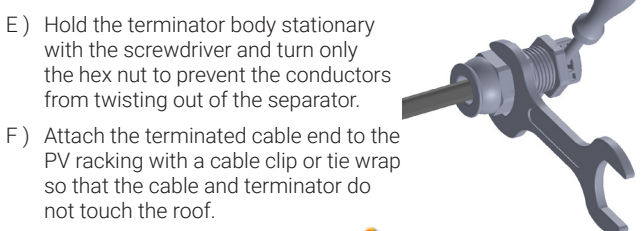

- Hold the terminator body stationary with the screwdriver and turn only the hex nut to prevent the conductors from twisting out of the separator.
- Attach the terminated cable end to the PV racking with a cable clip or tie wrap so that the cable and terminator do not touch the roof.



WARNING: The terminator can not be re-used. If you unscrew the nut, you must discard the terminator.

8 Complete Installation of the Enphase Q Aggregator or Junction Box

- Connect the Enphase Q Cable into the Enphase Q Aggregator or junction box.
- Use the ground lug on the Q Aggregator for module, rack, and balance of system grounding, if needed.

The Q Cable uses the following wiring color code:

Wire Colors
Black - L1
Red - L2

9 Connect the PV Modules



DANGER! Electric shock hazard. The DC conductors of this PV system are ungrounded and may be energized.

- If required, attach the Enphase DC bulkhead adaptors to the microinverters. Make sure they are fully seated. Do not reverse the adaptor connections.
- Connect the DC leads of each PV module to the DC input connectors or adaptors of the microinverter.
- Check the LED on the connector side of the microinverter. The LED flashes six times when DC power is applied.
- Mount the PV modules above the microinverters.

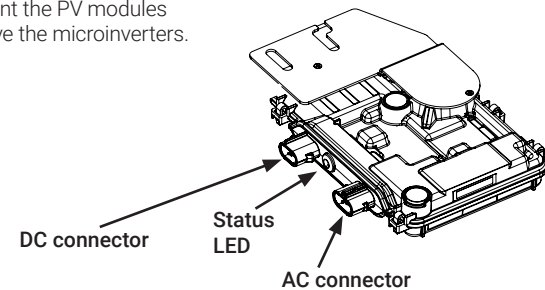

10 Energize the System

- Turn ON the AC disconnect or circuit breaker for the branch circuit.
- Turn ON the main utility-grid AC circuit breaker. Your system will start producing power **after a five-minute wait time**.
- Check the LED on the connector side of the microinverter:

LED	Indicates
Flashing green	Normal operation. AC grid function is normal and there is communication with the IQ Envoy.
Flashing orange	The AC grid is normal but there is no communication with the IQ Envoy.
Flashing red	The AC grid is either not present or not within specification.
Solid red	There is an active "DC Resistance Low, Power Off" condition. To reset, refer to the <i>Enphase IQ Envoy Installation and Operation Manual</i> at: http://www.enphase.com/support .

ACTIVATE MONITORING AND CONTROLS

After you have installed the microinverters, follow the procedures in the *Enphase IQ Envoy Quick Install Guide* to activate system monitoring, set up grid management functions, and complete the installation.

- Connecting the IQ Envoy
- Detecting devices
- Connecting to Enlighten
- Registering the system
- Building the virtual array

Enphase Connector Rating

Enphase Connectors on the cable assemblies in the following table have a maximum current of 20 A, a maximum OCPD of 20 A, and maximum ambient temperature of -40° to +79° C (-40° to +174.2° F) and are rated for disconnection under load.

Part Number	Model	Maximum Voltage
840-00387	Q-12-10-240	250 VAC
840-00388	Q-12-17-240	250 VAC
840-00389	Q-12-20-200	250 VAC
840-00385	Q-DCC-2	100 VDC
840-00386	Q-DCC-5	100 VDC

PV Rapid Shutdown Equipment (PVRSE)

This product is UL Listed as PV Rapid Shut Down Equipment and conforms with NEC-2014 and NEC-2015 section 690.12 and C22.1-2015 Rule 64-218 Rapid Shutdown of PV Systems, for AC and DC conductors, when installed according to the following requirements:

- Microinverters and all DC connections must be installed inside the array boundary. **Enphase further requires that the microinverters and DC connections be installed under the PV module to avoid direct exposure to rain, UV, and other harmful weather events.**
- The array boundary is defined as 305 mm (1 ft.) from the array in all directions, or 1 m (3 ft.) form the point of entry inside a building.

This rapid shutdown system must be provided with an initiating device and (or with) status indicator which must be installed in a location accessible to first responders, or be connected to an automatic system which initiates rapid shutdown upon the activation of a system disconnect or activation of another type of emergency system.

The initiator shall be listed and identified as a disconnecting means that plainly indicates whether it is in the "off" or "on" position. Examples are:

- Service disconnecting means
- PV system disconnecting means
- Readily accessible switch or circuit breaker

The handle position of a switch or circuit breaker is suitable for use as an indicator. Refer to NEC or CSA C22.1-2015 for more information.

Additionally, in a prominent location near the initiator device, a placard or label must be provided with a permanent marking including the following wording: **'PHOTOVOLTAIC SYSTEM EQUIPPED WITH RAPID SHUTDOWN'** The term 'PHOTOVOLTAIC' may be replaced with 'PV'.

The placard, label, or directory shall be reflective, with all letters capitalized and having a minimum height of 9.5 mm (3/8 in.) in white on red background.

SAFETY

IMPORTANT SAFETY INSTRUCTIONS SAVE THIS INFORMATION. This guide contains important instructions to follow during installation of the Enphase IQ 7A Microinverter.

	WARNING: Hot surface.
	WARNING: Refer to safety instructions.
	DANGER: Risk of electric shock.
	Refer to manual
	Double-Insulated

Safety Symbols

	DANGER: Indicates a hazardous situation, which if not avoided, will result in death or serious injury.
	WARNING: Indicates a situation where failure to follow instructions may be a safety hazard or cause equipment malfunction. Use extreme caution and follow instructions carefully.
	WARNING: Indicates a situation where failure to follow instructions may result in burn injury.
	NOTE: Indicates information particularly important for optimal system operation.

General Safety

	DANGER: Risk of electric shock. Do not use Enphase equipment in a manner not specified by the manufacturer. Doing so may cause death or injury to persons, or damage to equipment.
	DANGER: Risk of electric shock. Be aware that installation of this equipment includes risk of electric shock.
	DANGER: Risk of electric shock. The DC conductors of this photovoltaic system are ungrounded and may be energized.
	DANGER: Risk of electric shock. Always de-energize the AC branch circuit before servicing. Never disconnect the DC connectors under load.

General Safety, continued

	DANGER: Risk of electric shock. Risk of fire. Only use electrical system components approved for wet locations.
	DANGER: Risk of electric shock. Risk of fire. Only qualified personnel should troubleshoot, install, or replace Enphase Microinverters or the Enphase Q Cable and Accessories.
	DANGER: Risk of electric shock. Risk of fire. Ensure that all AC and DC wiring is correct and that none of the AC or DC wires are pinched or damaged. Ensure that all AC junction boxes are properly closed.
	DANGER: Risk of electric shock. Risk of fire. Do not exceed the maximum number of microinverters in an AC branch circuit as listed in this guide. You must protect each microinverter AC branch circuit with a 20A maximum breaker or fuse, as appropriate.
	DANGER: Risk of electric shock. Risk of fire. Only qualified personnel may connect the Enphase Microinverter to the utility grid.
	WARNING: Risk of equipment damage. Enphase male and female connectors must only be mated with the matching male/female connector.
	WARNING: Before installing or using the Enphase Microinverter, read all instructions and cautionary markings in the technical description, on the Enphase Microinverter System, and on the photovoltaic (PV) equipment.
	WARNING: Do not connect Enphase Microinverters to the grid or energize the AC circuit(s) until you have completed all of the installation procedures and have received prior approval from the electrical utility company.
	WARNING: When the PV array is exposed to light, DC voltage is supplied to the PCE.
	NOTE: To ensure optimal reliability and to meet warranty requirements, install the Enphase Microinverters and Enphase Q Cable according to the instructions in this guide.
	NOTE: Provide support for the Enphase Q Cable at least every 1.8 m (6 feet).
	NOTE: Perform all electrical installations in accordance with all applicable local electrical codes, such as the Canadian Electrical Code, Part 1 and NFPA 70 (NEC).
	NOTE: The AC and DC connectors on the cabling are rated as a disconnect only when used with an Enphase Microinverter.
	NOTE: Protection against lightning and resulting voltage surge must be in accordance with local standards.

Microinverter Safety

	DANGER: Risk of electric shock. Risk of fire. Do not attempt to repair the Enphase Microinverter; it contains no user-serviceable parts. If it fails, contact Enphase customer service to obtain an RMA (return merchandise authorization) number and start the replacement process. Tampering with or opening the Enphase Microinverter will void the warranty.
	DANGER: Risk of fire. The DC conductors of the PV module must be labeled "PV Wire" or "PV Cable" when paired with the Enphase Microinverter.
	WARNING: You must match the DC operating voltage range of the PV module with the allowable input voltage range of the Enphase Microinverter.
	WARNING: The maximum open circuit voltage of the PV module must not exceed the specified maximum input DC voltage of the Enphase Microinverter.
	WARNING: Risk of equipment damage. Install the microinverter under the PV module to avoid direct exposure to rain, UV, and other harmful weather events. Always install the microinverter bracket side up. Do not mount the microinverter upside down. Do not expose the AC or DC connectors (on the Enphase Q Cable connection, PV module, or the microinverter) to rain or condensation before mating the connectors.

Microinverter Safety, continued

	WARNING: Risk of equipment damage. The Enphase Microinverter is not protected from damage due to moisture trapped in cabling systems. Never mate microinverters to cables that have been left disconnected and exposed to wet conditions. This voids the Enphase warranty.
	WARNING: Risk of equipment damage. The Enphase Microinverter functions only with a standard, compatible PV module with appropriate fill-factor, voltage, and current ratings. Unsupervised devices include smart PV modules, fuel cells, wind or water turbines, DC generators, and non-Enphase batteries, etc. These devices do not behave like standard PV modules, so operation and compliance is not guaranteed. These devices may also damage the Enphase Microinverter by exceeding its electrical rating, making the system potentially unsafe.
	WARNING: Risk of skin burn. The chassis of the Enphase Microinverter is the heat sink. Under normal operating conditions, the temperature could be 20°C above ambient, but under extreme conditions the microinverter can reach a temperature of 90°C. To reduce risk of burns, use caution when working with microinverters.
	NOTE: The Enphase Microinverter has field-adjustable voltage and frequency trip points that may need to be set, depending upon local requirements. Only an authorized installer with the permission and following requirements of the local electrical authorities should make adjustments.

Enphase Q Cable Safety

	DANGER: Risk of electric shock. Do not install the Enphase Q Cable terminator while power is connected.
	DANGER: Risk of electric shock. Risk of fire. When stripping the sheath from the Enphase Q Cable, make sure the conductors are not damaged. If the exposed wires are damaged, the system may not function properly.
	DANGER: Risk of electric shock. Risk of fire. Do not leave AC connectors on the Enphase Q Cable uncovered for an extended period. You must cover any unused connector with a sealing cap.
	DANGER: Risk of electric shock. Risk of fire. Make sure protective sealing caps have been installed on all unused AC connectors. Unused AC connectors are live when the system is energized.
	WARNING: Use the terminator only once. If you open the terminator following installation, the latching mechanism is destroyed. Do not reuse the terminator. If the latching mechanism is defective, do not use the terminator. Do not circumvent or manipulate the latching mechanism.
	WARNING: When installing the Enphase Q Cable, secure any loose cable to minimize tripping hazard
	NOTE: When looping the Enphase Q Cable, do not form loops smaller than 12 cm (4.75 inches) in diameter.
	NOTE: If you need to remove a sealing cap, you must use the Enphase disconnect tool.
	NOTE: When installing the Enphase Q Cable and accessories, adhere to the following: <ul style="list-style-type: none"> Do not expose the terminator or cable connections to directed, pressurized liquid (water jets, etc.). Do not expose the terminator or cable connections to continuous immersion. Do not expose the terminator or cable connections to continuous tension (e.g., tension due to pulling or bending the cable near the connection). Use only the connectors and cables provided. Do not allow contamination or debris in the connectors. Use the terminator and cable connections only when all parts are present and intact. Do not install or use in potentially explosive environments. Do not allow the terminator to come into contact with open flame. Fit the terminator using only the prescribed tools and in the prescribed manner. Use the terminator to seal the conductor end of the Enphase Q Cable; no other method is allowed.

Enphase Customer Support: enphase.com/en-us/support/contact